

NOTES:

- HUOSING: PA9T HIGH-TEMP THERMOPLASTIC UL94V-0 COLOR:CREAM-COLOURED
- TERMINAL:PHOSPHOR BRONZE  
PLATING:1μ" GOLD FLASH OVERALL 50~100μ" NICKEL UNDER PLATED.
- CODING INFORMATION: 5001-BDC 0850-\*\*-\*\*MR

PACKING: R: REEL  
MALE  
PIN  
MATING HEIGHT: 50-5.0H

0.8BTB

JM CONN BTB CONNECTOR SERIES

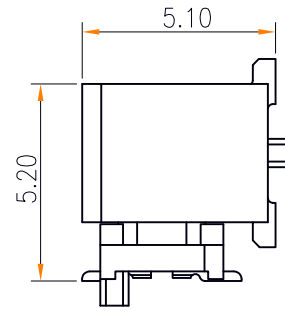
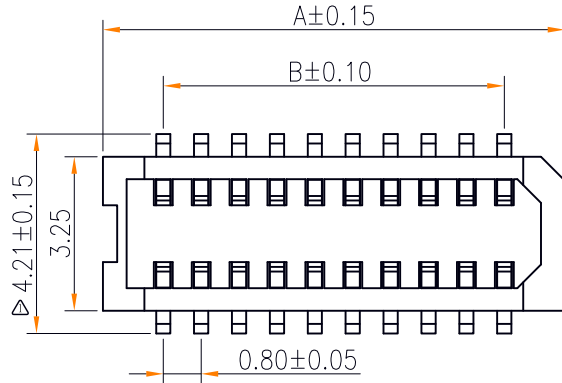

MATING HEIGHT  
SCALE:1.25:1

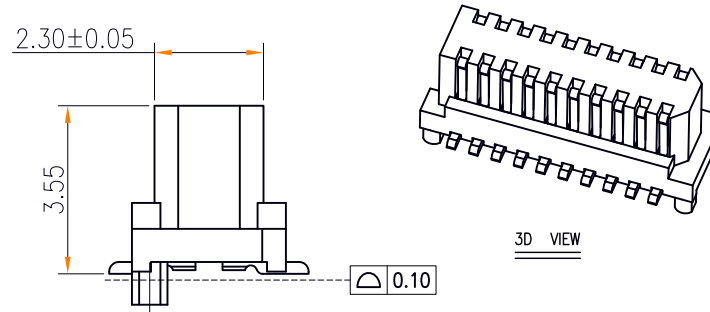
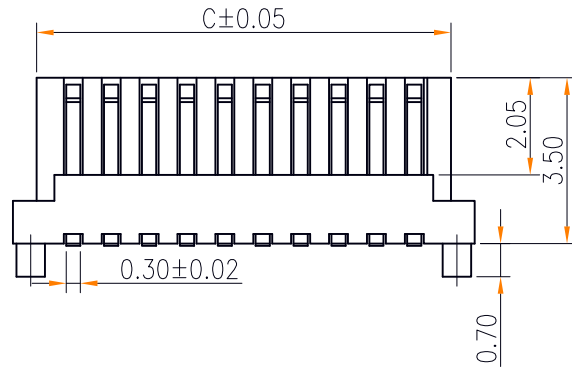

3D VIEW

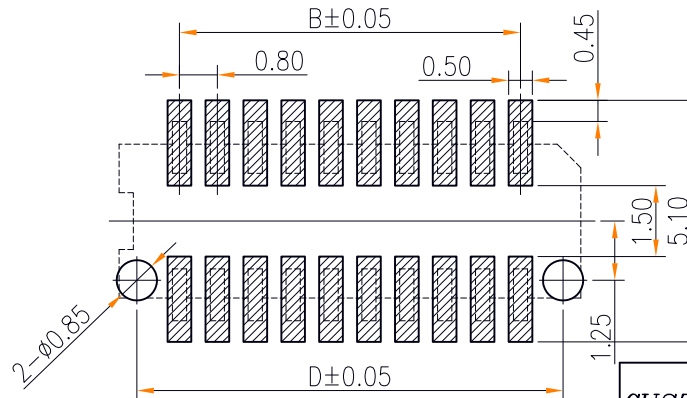
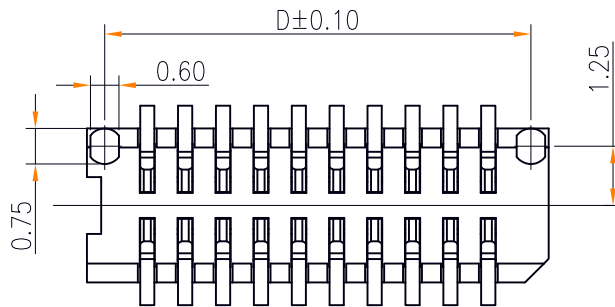

RECOMMENDED PCB PATTERN DIM.

TOLERANCE : ±0.05

NO. of contacts	Dimensions			
	A.	B.	C.	D.
4	3.35	0.80	2.35	2.60
6	4.15	1.60	3.15	3.40
8	4.95	2.40	3.95	4.20
10	5.75	3.20	4.75	5.00
12	6.55	4.00	5.55	5.80
14	7.35	4.80	6.35	6.60
16	8.15	5.60	7.15	7.40
18	8.95	6.40	7.95	8.20
20	9.75	7.20	8.75	9.00
22	10.55	8.00	9.55	9.80
24	11.35	8.80	10.35	10.60
26	12.15	9.60	11.15	11.40
28	12.95	10.40	11.95	12.20
30	13.75	11.20	12.75	13.00
32	14.55	12.00	13.55	13.80
34	15.35	12.80	14.35	14.60
36	16.15	13.60	15.15	15.40
38	16.95	14.40	15.95	16.20
40	17.75	15.20	16.75	17.00
42	18.55	16.00	17.55	17.80
44	19.35	16.80	18.35	18.60
46	20.15	17.60	19.15	19.40
48	20.95	18.40	19.95	20.20
50	21.75	19.20	20.75	21.00
52	22.55	20.00	21.55	21.80

CUSTOMER 深圳市文章济美科技有限公司

一般公差 GENERAL TOLERANCE .X ±0.25 .XX ±0.15 .XXX ±0.05 ANGLES ±1°	制图 (DR): Kavin 2016.07.05	品名(TITLE): 0.8mm 侧插BTB
审核 (CHKD):	料号(PART NO): 5001-BDC0850-**-**MR	比例(SCALE) 1:8
版本 (REV) B	单位(UNITS) mm	张数(SHEET) 1 OF 1
核准 (APPD):	图幅(SIZE) A4	

RoHS Compliant  
2013/95/EC

新增焊锡脚位尺寸	Kavin	08/15/17
修订 SER	修改摘要 REVISION DESCRIPTION	签名 SIGNATURE
	日期 DATE	

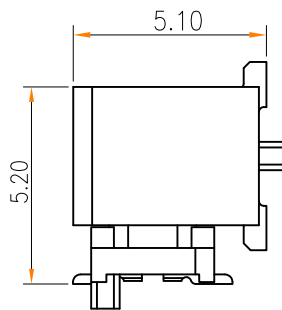
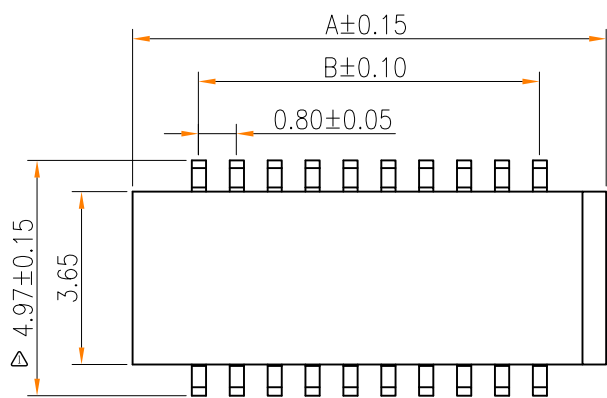

MATING HEIGHT  
SCALE: 1.25:1

NOTES:

- HUOSING: PA9T HIGH-TEMP THERMOPLASTIC UL94V-0 COLOR:CREAM-COLOURED
- TERMINAL:PHOSPHOR BRONZE  
PLATING:1μ" GOLD FLASH OVERALL 50~100μ" NICKEL UNDER PLATED.
- CODING INFORMATION: 5001-BDC 0850-\*\*-\*\*FR

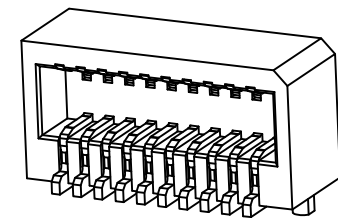
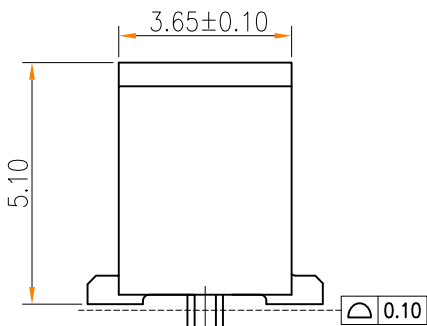
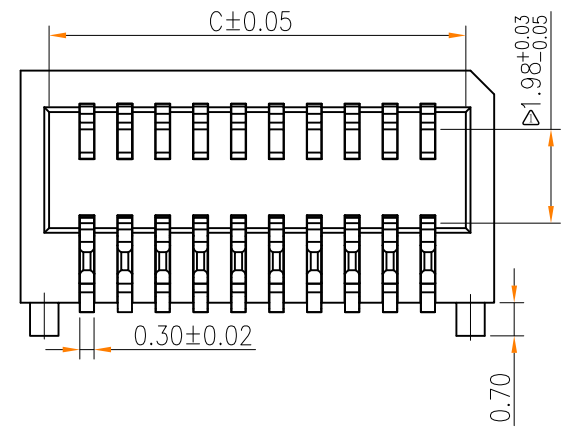
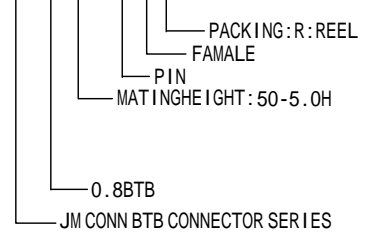

3D VIEW

NO. of contacts	Dimensions			
	A.	B.	C.	D.
4	3.60	0.80	2.40	2.60
6	4.40	1.60	3.20	3.40
8	5.20	2.40	4.00	4.20
10	6.00	3.20	4.80	5.00
12	6.80	4.00	5.60	5.80
14	7.60	4.80	6.40	6.60
16	8.40	5.60	7.20	7.40
18	9.20	6.40	8.00	8.20
20	10.00	7.20	8.80	9.00
22	10.80	8.00	9.60	9.80
24	11.60	8.80	10.40	10.60
26	12.40	9.60	11.20	11.40
28	13.20	10.40	12.00	12.20
30	14.00	11.20	12.80	13.00
32	14.80	12.00	13.60	13.80
34	15.60	12.80	14.40	14.60
36	16.40	13.60	15.20	15.40
38	17.20	14.40	16.00	16.20
40	18.00	15.20	16.80	17.00
42	18.80	16.00	17.60	17.80
44	19.60	16.80	18.40	18.60
46	20.40	17.60	19.20	19.40
48	21.20	18.40	20.00	20.20
50	22.00	19.20	20.80	21.00
52	22.80	20.00	21.60	21.80

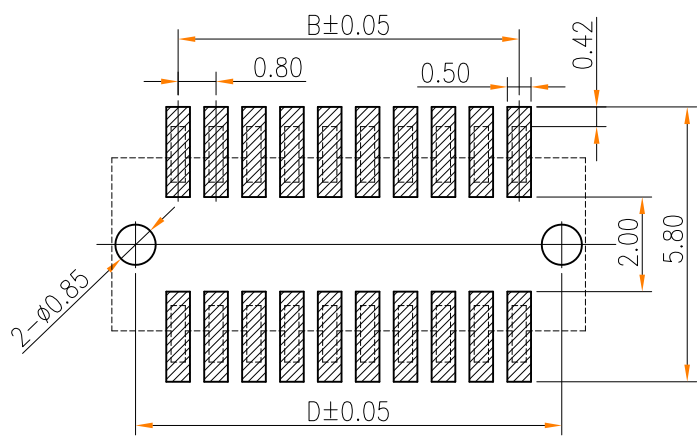
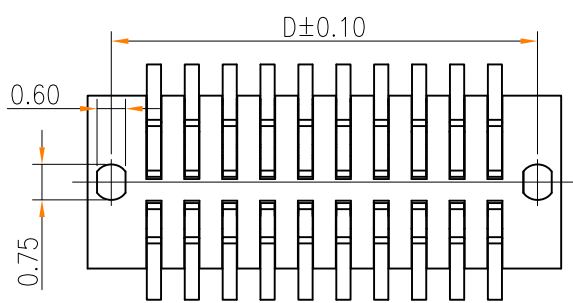

RECOMMENDED PCB PATTERN DIM.

TOLERANCE : ±0.05

CUSTOMER		深圳市文章济美科技有限公司			
一般公差 GENERAL TOLERANCE	制图 (DR): Kavin 2016.07.05	品名 (TITLE):	0.8mm 侧插BTB		
.X ±0.25 .XX ±0.15 .XXX ±0.05 ANGLES ±1°	审核 (CHKD):	料号 (PART NO):	5001-BDC0850-**-**FR		
版本 (REV) B	比例 (SCALE)	单位 (UNITS)	张数 (SHEET)	图幅 (SIZE)	
新增焊锡脚位尺寸及接触GAP值 Kavin 08/15/17	1:8	mm	1 OF 1	A4	



修订 (REV)	修改摘要 (REVISION DESCRIPTION)	签名 (SIGNATURE)	日期 (DATE)